

 **PLASSON**<sup>®</sup>  
AUSTRALIA

# Assembly Instructions

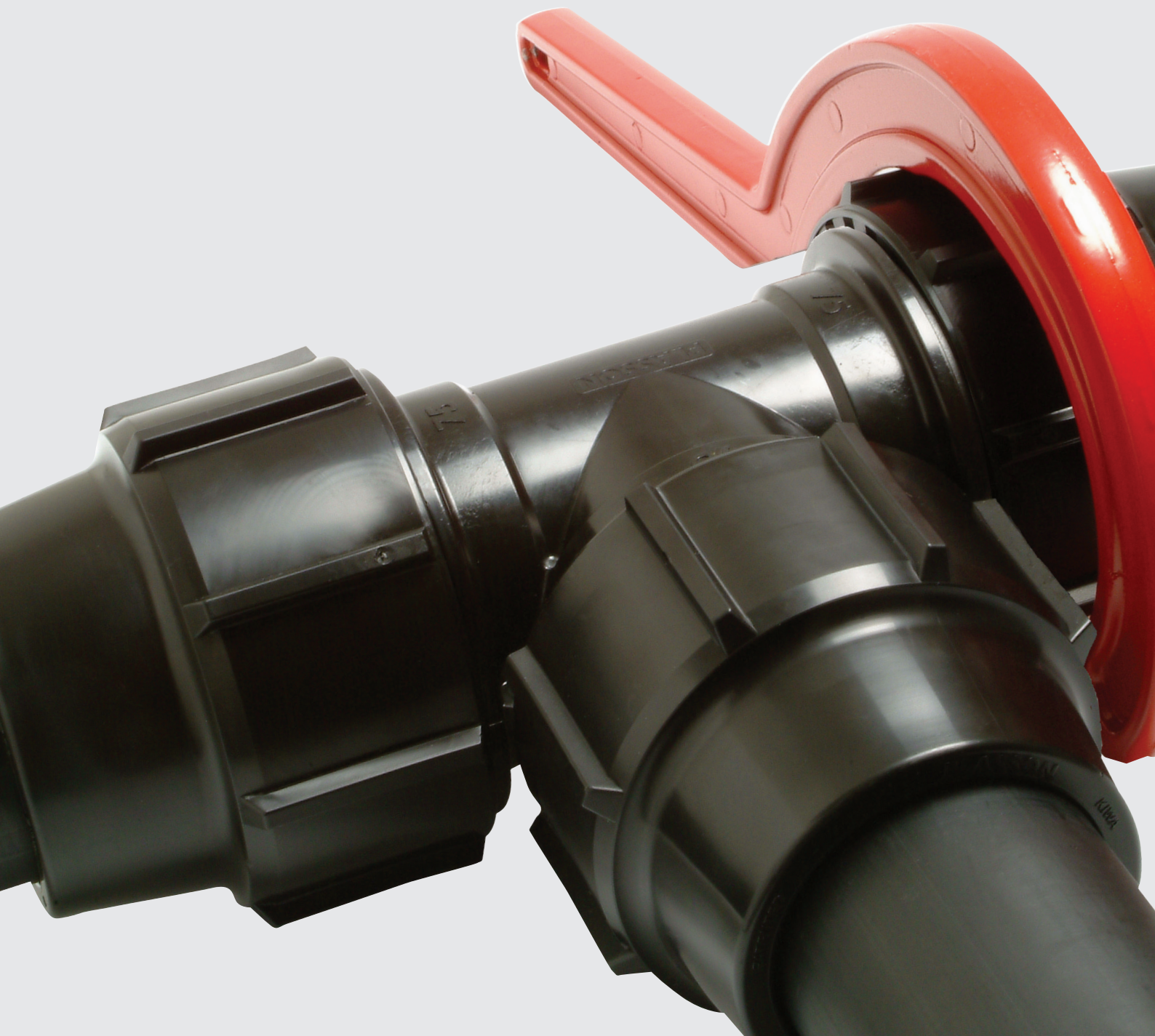

# Store Locator

When customers want to buy Plasson, make sure they can find you.

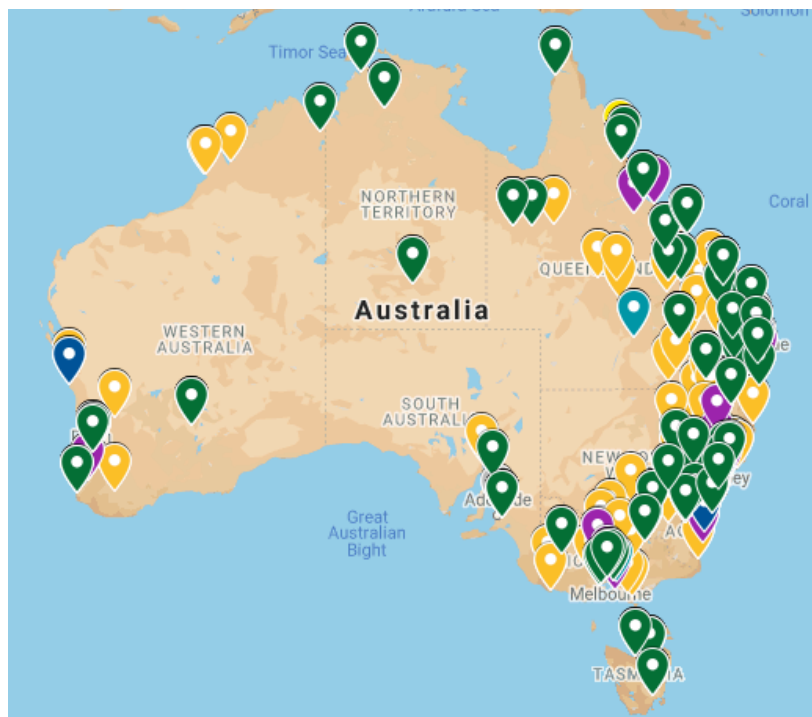

Register your store today at  
[plasson.com.au](http://plasson.com.au)



# Global Presence - Local Commitment

**Plasson is a global leader in the development and manufacture of innovative solutions for connecting polyethylene and other pipelines.**

We started with fittings for agricultural irrigation and have now developed solutions and systems for water, gas, waste and chemical pipelines.

Fluid delivery systems throughout the world owe their excellence to Plasson's innovative research and development.

Plasson fittings have proved to be the most reliable connection systems for polyethylene pipeline systems in Australian conditions for over 40 years.

Plasson delivers state-of-art products to a variety of industries including irrigation, rural, water utilities, plumbing, mining and gas distribution.

## **Why Choose Plasson?**

- ✓ Same reliable design for over 40 years
- ✓ Hand tight assembly for most sizes: No wrenches – No hassles – No leaks
- ✓ Captive O-Ring for ease of installation & cannot be lost during assembly or reuse
- ✓ Largest fitting range
- ✓ Vast range of adaptor and conversion kits
- ✓ Extensive stock
- ✓ Best logistics and stock systems

## **Sizes**

- ✓ Rural to 2"
- ✓ Metric to 160mm
- ✓ Mechanical tapping saddles to 2" and 180mm
- ✓ BSP threaded fitting to 4"
- ✓ Valves to 4"
- ✓ Electrofusion fittings systems and equipment to 1200mm

**Stay Connected – Follow us on Social Media**





## QUESTIONS ABOUT PE? PLASSON HAS THE ANSWERS.

Polyethylene offers the ideal cost-effective and technically superior alternative to other materials, requiring minimal effort to install, reducing the number of connections required and increasing the system lifespan.

With over 40 years of installed history in the harshest of Australian conditions, Plasson fittings are the toughest, most reliable and easiest to install poly pipe fittings available.

With a team of knowledgeable specialists, local expertise and authoritative field support, the answer to any questions on PE is waiting at Plasson.

## TABLE OF CONTENTS

|   |            |
|---|------------|
| <b>ASSEMBLY INSTRUCTIONS</b> .....                            | <b>189</b> |
| 1/2" - 2" RURAL FITTINGS.....                                 | 190        |
| 16 - 63MM METRIC FITTINGS.....                                | 191        |
| 75 - 125MM METRIC FITTINGS.....                               | 192        |
| 63 - 125MM METRIC MINE SAFE FITTINGS.....                     | 193        |
| 160MM COUPLER.....  | 194        |
| MODULAR ADAPTOR.....  | 195        |
| REDUCING SET 63 - 20MM AND COMBINATIONS .....                 | 196        |
| REDUCING SET 110 - 63MM AND COMBINATIONS.....                 | 196        |
| POLY TO COPPER FITTINGS.....                                  | 197        |
| POLY TO COPPER ADAPTOR KITS.....                              | 197        |
| SLIP/REPAIR COUPLER 20 - 63MM.....                            | 198        |
| SLIP/REPAIR COUPLER 63 (MINE) - 125MM.....                    | 199        |
| UNIVERSAL SLIP REPAIR COUPLER .....                           | 200        |
| METRIC STEEL / PVC ADAPTOR / REPAIR COUPLING- THRUSTED.....   | 201        |
| METRIC STEEL / PVC ADAPTOR / REPAIR COUPLING- UNTHRUSTED..... | 201        |

# Assembly Instructions

## 1/2" - 2" Rural Hand Tight Fittings

For a leakproof connection that will last a lifetime:

- ✓ Ensure the surface of the pipe to be inserted into the fittings is free of scratches and other imperfections
- ✓ Ensure both the end of the pipe and the fitting itself are clean of sand, mud, stones, etc
- ✓ Do not over tighten nut - max 1/2 turn past hand tight if using a wrench.  
NEVER use wrenches or spanners with handle lengths longer than 22cm.
- ✓ Excessive torque during tightening can spread the nut cone and result in pull outs
- ✓ If fittings are reused, ensure split ring is sharp and bites into pipe to avoid pull outs
- ✓ Replace worn split rings
- ✓ Use PTFE tape in threaded connections

1



Cut pipe square, deburr and chamfer internal edge of pipe with knife.  
Separate components of fitting and mount them on pipe - first the nut, followed by the split ring. Make sure the large end of the split ring faces towards the fitting.

2



Insert barbed end of tail into pipe so that the flange is hard against pipe face.  
If necessary, use a rubber mallet or piece of timber and hammer.

3



Insert spigot end of tail into body of fitting until it passes through rubber o-ring and flange butts against shoulder of fitting.  
Push split ring hard against flange.

4



Firmly hand tighten nut onto fitting body.

HAND  
TIGHTEN



**Note:** With 1/2" size use 16mm metric fittings.  
Pipe tail adaptor is not required.  
Use metric assembly instructions.

# Assembly Instructions

## 16 - 63mm Metric Fittings

1



Cut pipe square, remove burrs and chamfer the end of the pipe with a file or chamfering tool. Use of a silicon based lubricant will ease the force required for pipe insertion.

2



Undo nut up to the last thread. Do not remove the nut. If the nut is removed care should be taken to ensure pipe is inserted square to the fitting.

3



Twist the pipe into the fitting through the nut and split ring until it meets the first resistance pushing against the captive o-ring. Push and twist the pipe past the o-ring until it stops at pipe stop inside the fitting - the final stop.

4













HAND  
TIGHTEN



16-32mm Firmly hand tighten.  
40-63mm Hand tighten then use a wrench for maximum further half turn.  
Wrench handle length should not exceed 22cm.

# Assembly Instructions predictable and safe joining of coiled pipe

## 75 - 125mm Metric Fittings

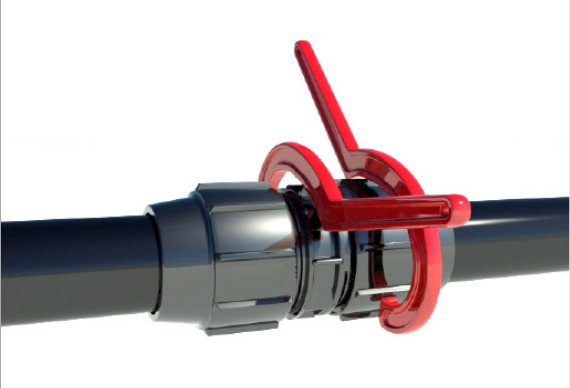
|   |   |   |  |
|---|---|---|--|
| <p>1</p> <p>NOT INSTALLED YET</p>    |  <p>Cut the pipe square. Remove nut and split ring. Reposition nut, bush and o-ring on pipe 2x diameters back. Lubricate pipe and o-ring.</p>  | <p>2</p> <p>NOT INSTALLED YET</p>    |  <p>Push the pipe fully into the fitting body until stopped by the internal stop. Push the o-ring and plastic bush forward against the fitting. (They will not enter the body of the fitting).</p> |
| <p>3</p> <p>NOT INSTALLED YET</p>  |  <p>Tighten nut to push the bush and o-ring right into the fitting until the bush is flush with fitting mouth.</p>   | <p>4</p> <p>NOT INSTALLED YET</p>  |  <p>Fully unscrew nut and pull back along pipe.</p>  |
| <p>5</p> <p>NOT INSTALLED YET</p>  |  <p>Open split ring and place on pipe with lugs touching bush. When reusing fittings, remove and destroy the old grip ring, replacing it with a new grip ring. Worn grips will not bite into pipe.</p> | <p>6</p> <p>NOT INSTALLED YET</p>  |  <p>Firmly hand tighten and then 1/2 turn with wrenches. Maximum handle length 45cm.<br/><b>Never overtighten nuts as this can cause blowouts.</b></p>   |



# Assembly Instructions

## Metric MineSafe Fittings 63 - 125mm

**1**



NOT INSTALLED YET

Cut the pipe square. Remove nut and split ring. Reposition nut, bush and o-ring on pipe 2x diameters back. Lubricate pipe and o-ring.



**2**



NOT INSTALLED YET

Push the pipe fully into the fitting body until stopped by the internal stop. Push the o-ring and plastic bush forward against the fitting. (They will not enter the body of the fitting).



**3**



NOT INSTALLED YET

Tighten nut to push the bush and o-ring right into the fitting until the bush is flush with fitting mouth.



**4**



NOT INSTALLED YET

Fully unscrew nut and pull back along pipe.



**5**



Open split ring and place on pipe with lugs touching bush. When reusing fittings, remove and destroy the old grip ring, replacing it with a new grip ring. Worn grips will not bite into pipe.



**6**



Firmly hand tighten and then 1/2 turn with wrenches. Maximum handle length 45cm.

**Never overtighten nuts as this can cause blowouts.**

# Assembly Instructions

## 160mm Coupler



1. Undo and take out bolts and nuts.
2. Take the two shell halves apart.
3. Remove the exposed sleeve and o-ring and place over the pipe end.
4. Push fitting completely home over pipe end.
5. Push o-ring and sleeve into original position.
6. Place the two shell halves with grip rings inserted over pipe and fitting body. Now insert bolts, washers and nuts and tighten until the shells are in contact with each other.

## Universal Adaptor and 90° Elbow



1. Remove any unsound material adhering to the pipe.
2. Select correct fitting using the Plasson gauge to measure the pipe.
3. Cut and de-burr pipe as necessary.
4. Slide the Plasson Universal Adaptor fitting end onto the pipe until the first resistance point.
5. Tighten the nut against the body. Final tightening to be done with a Plasson wrench or similar.
6. Assemble the metric PE joint following the standard fitting instructions.

# Assembly Instructions

## Modular Adaptor

1

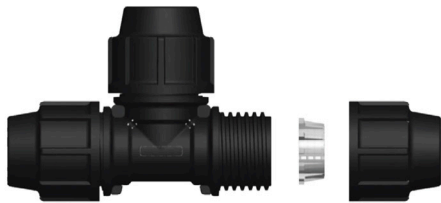

The modular adaptor may be used with a wide variety of Plasson Series 7 compression fittings. Tee fittings are shown for illustration purposes.

2

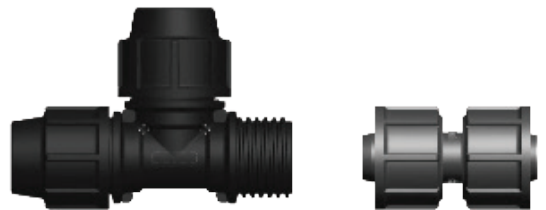

Remove nut and split ring and set them aside.

3



Assemble adaptor on fitting body, hand tighten nut then add 1/2 turn with Plasson wrench. The nut need not reach the last thread for an effective seal.

4

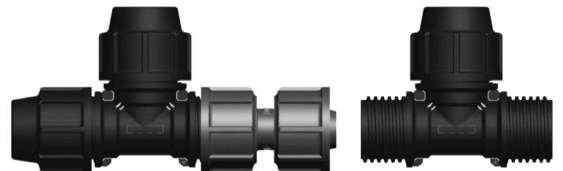

Repeat procedure with a second fitting body.

5



The assembly is ready for a third fitting or for nut and split ring.

# Assembly Instructions

## Reducing Set 63 - 20mm and Combinations



Note: Preassembled 110-63 fittings are available. See page 53

1. Remove nut from fitting and discard white split ring.
2. Slide nut, grey nut reducer(s) and white split ring from set onto the pipe as shown.
3. Make a mark on the pipe to depth of Reducing Bush.
4. Push pipe into bush up to the mark you have made.
5. Push reducing bush and pipe into body of the fitting until the shoulder of the reducing bush reaches the end of the fitting. Some lubricant at this point would be of help.
6. Draw the split ring and grey nut reducer(s) close to the body of the fitting.
7. Hand tighten and a maximum half turn past hand tight with a Plasson wrench. Maximum handle length 22cm.

## Reducing Set 110 - 63mm and Combinations

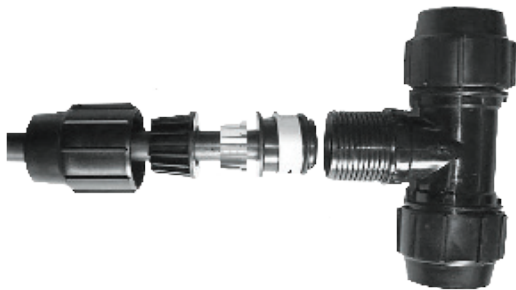

1. Cut pipe square, remove burrs.
2. Remove nut from fitting and discard white split ring.
3. Insert reducing adaptor into fitting body. It will be stopped by the resistance of the internal o-ring.
4. Reposition nut onto fitting body.
5. Tighten nut with a wrench to push the reducing adaptor in through the o-ring until its shoulder abuts fitting bushing.
6. Unscrew nut from fitting.
7. Mount the nut, nut reducer and 63 white split ring (with large end facing the fitting) on the pipe.
8. Twist the pipe into the reducer through the seal to the pipe stop. Lubrication and chamfering of the pipe end will ease insertion of the pipe. Use a silicone lubricant.
9. Slide split ring to abut the reducer.
10. Hand tighten nut firmly and a further 1/2 turn with a Plasson wrench or a wrench with maximum handle length of 22cm.

# Assembly Instructions

## Poly to Copper Fittings



1. Fittings supplied with copper nut. Release the terracotta coloured nut half a turn.
2. Mark a line 6cm (2½") from the end of the ½" copper pipe or mark a line 7cm (2¾") from the end of the ¾" or 1" copper pipe.
3. Lubricate the copper tube.
4. Slide the copper pipe into the fitting until the marked line reaches the end of the nut.
5. Firmly hand tighten nut.
6. Use wrench for a further three quarter turn past hand tight for final tightening.

Note: If reused, the metal grip ring must be replaced with a new one. The 25mm (1") adaptor does not include a rubber sleeve.

## Poly to Copper Adaptor Kits

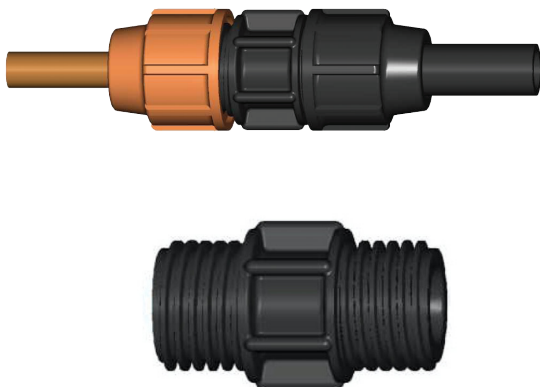

DN15 (½") copper fits into 20mm Plasson compression end. Discard black 20mm Plasson nut, discard the white split ring, slide rubber liner into fitting body, position cone and SS ring inside copper coloured nut as shown in picture above. Reassemble to the Plasson body. Fit copper pipe as above.

DN20 (¾") copper fits into 25mm Plasson compression end. Assemble as above with 25mm Plasson compression end.

DN25 (1") copper fits into 25mm Plasson compression end. The rubber liner is not required as the copper is fitted into the fitting through the captive o-ring. Assemble as above with 25mm Plasson compression end.

The unused black Plasson nuts and white split rings can be saved and used with Plasson bodies.

Note: Adaptor Kits fit into Plasson Reducing Sets.

# Assembly Instructions

## Slip Repair Coupler 20 - 63mm

1

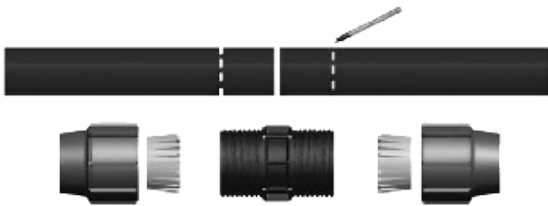

Mark insertion depth on pipe ends.  
Lubricate o-rings with inert lubricant.

2



Lift pipe end and slip nut, split ring and body fully onto pipe as shown.

Lift other pipe end and slip remaining nut and split ring onto it.

3



Realign pipe ends, then twist and push coupler body into place, ensuring that the insertion depth lines meet fittings body.

Position split rings adjacent to body.

4



Assemble nuts on fitting body, hand tighten firmly then add 1/2 turn with Plasson wrench or wrench handle with length not exceeding 22cm.

# Assembly Instructions

## Slip Repair Coupler DN63 (Mine) - 125mm

1

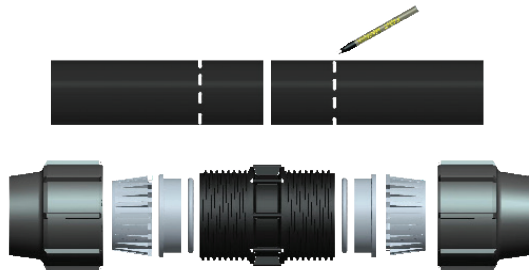

Mark insertion depth on pipe ends.  
Lubricate o-rings with inert lubricant.

2

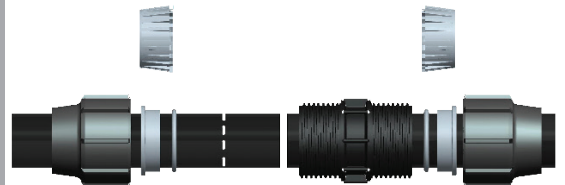

Put split rings aside, lift pipe end and slip nut, bush, o-ring and body fully onto pipe as shown.  
Lift other pipe end and slip remaining nut, bush and o-ring onto it.

3

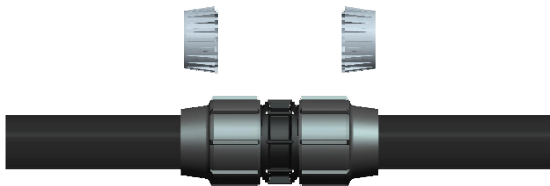

Realign pipe ends, then twist and push coupler body into place, ensuring that the insertion depth lines meet fitting body.  
Position o-rings and bush adjacent to body, and tighten nuts as shown.

4

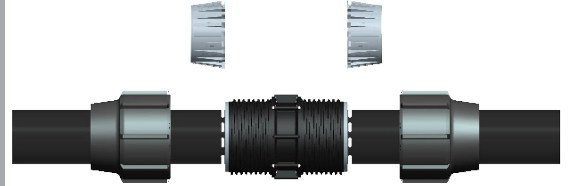

Fully unscrew nuts and pull back along pipe. Bush should be flush with body (as shown in picture).

5



Assemble split rings on pipe adjacent to fitting body and tighten nuts on fitting.

6



Firmly hand tighten and further 1/2 turn with a wrench - maximum handle length 22cm.

# Assembly Instructions

## Universal Slip Repair Coupler

1



Mark pipe insertion depth on the pipe (approx. half the fitting length). Undo nuts 1 to 2 turns while ensuring they remain on the fitting.

2



Insert the pipe until the mark is inline with the end of the nut.

3



While holding the fitting body with a Plasson wrench (or a similar tool) tighten the nut firmly with another wrench. **Note:** If the fitting is to be reused, check all of the metal teeth are still in the white grip ring - if not, replace the old grip ring with a new one.



# Assembly Instructions

## Metric Steel / PVC Adaptor / Repair Coupling - Thrusted

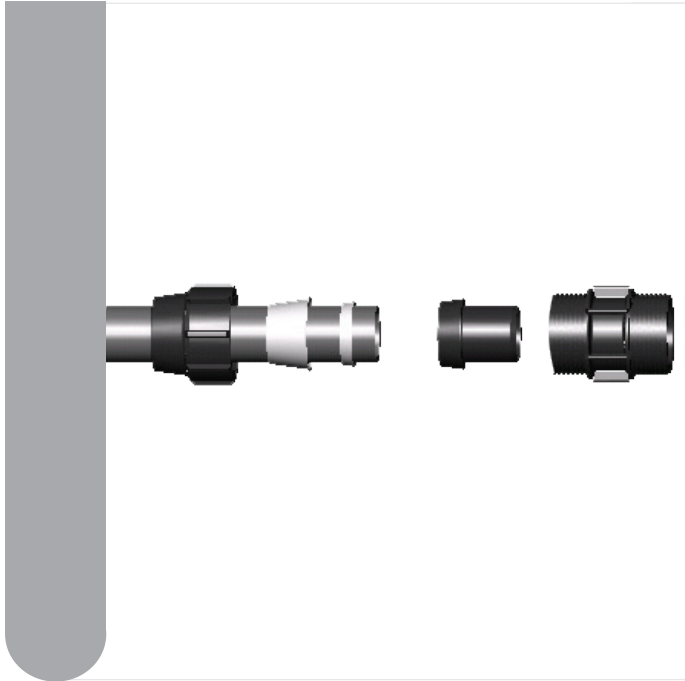

1. Unscrew nut from fitting. Discard with plastic split ring.
2. Slide nut s/steel Cone and s/steel Split ring onto the steel/pvc pipe in that order.  
Please note: The s/steel Grip ring has to be positioned with the external taper sloping towards the steel cone, i.e., the s/steel Grip ring will nest properly in the steel cone.
3. Fit rubber sleeve onto the steel/pvc pipe up to the stop.
4. Moisten the rubber sleeve and insert the steel/pvc pipe and sleeve into the fitting. Ensure it has properly passed the o-ring.
5. Move stainless steel grip split ring until it touches the conical side of the rubber sleeve. Move the steel cone so that it is positioned over the rubber cone.
6. Tighten the nut onto the body of the fitting using a plasson wrench or a spanner with maximum handle length of 46cm. This fitting, when assembled, is full thrusted and requires no special support or clamping to restrain the pipe and fitting.

## Metric Steel / PVC Adaptor / Repair Coupling - Unthrust



1. Unscrew nut from fitting and discard plastic split ring.
2. Slide nut onto the steel/pvc pipe.
3. Fit rubber\* sleeve onto the steel/pvc pipe up to the stop.
4. Moisten the rubber sleeve and insert the steel/pvc pipe and sleeve into the fitting. Ensure it has properly passed the o-ring.
5. Tighten the nut onto the body of the fitting using a plasson wrench or a spanner with maximum handle length of 46cm.

Note: This fitting\*\*, when assembled, is unthrust and requires support and clamping to restrain the pipe and fitting.  
\*Rubber is NBR.  
\*\*Pressure rating is the same as normal Plasson fitting.

Important: When inserting plastic pipes and/or plastic fittings into existing steel pipework, care must be taken to ensure that existing electrical earth continuity is maintained.

## Terms and Conditions

### 1. DEFINITIONS

"Agreement" means the agreement for supply of Goods between PLASSON and the Customer of which these "Conditions of Sale" form part.

"Charges" includes all monies payable by the Customer to PLASSON in relation to the supply of goods.

"Confirmation of Order" means a written document which sets out a description of the Goods, the Charges and other necessary terms and which may include details of the Customer's offer to purchase the Goods.

"Customer" means the entity which orders Goods from PLASSON or to which Goods are delivered by PLASSON and includes the Customer's agents and permitted assigns.

"Ex Works" has the same meaning as is ascribed to that term in Incoterms 1990.

"Goods" includes parts and supplies which may subsequently be supplied under any warranty given in relation the Goods.

"GST" means goods and services tax imposed in Australia by the GST law.

"PLASSON" means Plasson Australia Pty Ltd ACN 053 788 891, its agents and assigns.

"Permitted Security Interest" means any security interest which PLASSON consents to or otherwise agrees in writing with the Customer will be a Permitted Security Interest for the purposes of these terms and conditions. "Persons" includes corporations, partnerships and unincorporated associations.

Words importing the singular number shall include the plural and vice versa.

"PPSA" means the Personal Property Securities Act 2009 (Cth) as amended. "PPSR" means the Personal Property Security Register. "Purchase Money Security Interest" that has the meaning prescribed to it in the PPSA. "Security Interest" includes any security interest under the PPS Act.

### 2. CONDITIONS

2.1. These Conditions of Sale apply to all agreements for the supply of Goods by PLASSON and are varied or excluded only where such variation or exclusion is in writing and signed by a director of PLASSON and either is expressed to be a variation of these Conditions or is so inconsistent with them as to allow no other interpretation than that there has been an intentional variation of them.

2.2. Where a Customer has agreed to purchase goods from PLASSON upon the basis of these Conditions of Sale, these Conditions of Sale shall be incorporated into every subsequent agreement for purchase of Goods by that Customer from PLASSON unless specifically varied or excluded in the manner prescribed by clause 2.1.

### 3. QUOTATIONS AND ENTRY INTO AGREEMENT

3.1. No brochure, catalogue, price list, quotation or other communication published or forwarded by PLASSON to the Customer, whether in writing or not, shall constitute anything other than an invitation by PLASSON to the Customer to do business and shall not represent that the Goods or Charges referred to in them shall be available to the Customer. Any purchase order placed by the Customer with PLASSON constitutes only an offer to purchase Goods. Notwithstanding any prior communication between PLASSON and the Customer, there shall be no obligation by PLASSON to accept an offer to purchase Goods made by a Customer. The Customer's offer is only accepted by PLASSON issuing a Confirmation of Order to the Customer.

3.2. In the event of any inconsistency between the Customer's purchase order or other request and PLASSON's Confirmation of Order (which includes these Conditions), the terms of the Confirmation of Order shall prevail.

3.3. Unless otherwise stated in the Confirmation of Order prices quoted are exclusive of GST and the Customer is required to pay any GST payable by PLASSON in respect to the supply of Goods at the same time as the price is required to be paid by the Customer to PLASSON.

### 4. FUNCTIONALITY AND PERFORMANCE

4.1. All information, specifications or other data provided by PLASSON in relation to the Goods represent approximations only and small deviations or slight variations from them which do not substantially diminish the functionality or performance of the Goods will not entitle the Customer to either reject the Goods or make any claim in respect of them.

4.2. Information provided by PLASSON in relation to the performance of Goods represents only a guide as to the performance of the Goods under optimum operating conditions.

4.3. Without limiting the operation of Clause 4.2, PLASSON may at its sole discretion provide the Customer with training manuals and other materials in relation to the Goods. PLASSON gives no representation or warranty as to the accuracy of such materials or the use of them by the Customer.

### 5. CHARGES

5.1. The Customer shall pay to PLASSON all Charges within thirty (30) days from the date of the Invoice without reduction or deferment on account of any claim, counterclaim or setoff.

5.2. The Customer acknowledges that the cost of transportation and freight for the Goods is not included in the Charges and the Customer shall pay a reasonable additional fee for such costs. All other charges such as duty, insurance and taxes and other related expenses shall unless otherwise agreed in writing) be paid by the Customer.

5.3. Should the Customer fail to pay any amount when due to PLASSON, the Customer shall be liable to pay to PLASSON without demand interest thereon at the rate of 1% above the rate charged on commercial overdraft accounts in excess of \$100,000.00 applicable from time to time and charged by PLASSON's bankers as nominated by Plasson at the relevant time. Interest payable hereunder shall be compounded monthly and calculated from the due date for payment to the date upon which payment is actually made.

5.4. Notwithstanding anything else appearing in the Agreement, all Charges shall immediately become due if the Customer shall fail to make any payment when due or shall become subject to the bankruptcy laws or enter into any composition with its creditors or enter into any liquidation or suffer a receiver or receiver and manager to be appointed for all or part of its assets.

5.5. Where payment of the Charges or part of the Charges is due prior to delivery of the Goods and where the Customer fails to make such payment, PLASSON may withhold delivery and give the customer a notice requiring payment to be made within seven days. Should the Customer fail to make the payment which is due within the time required by the notice, PLASSON may terminate the Agreement.

### 6. PROPERTY OF GOODS PURCHASED

6.1. No legal or equitable title to the Goods shall pass to the Customer until payment in full has been made by the Customer not only of all Charges for all Goods the subject of the Agreement (unless waived in writing by PLASSON) but also until payment has been made of all Charges for all goods previously supplied by PLASSON to the Customer.

6.2. Subject to Clause 6.5, until the legal and equitable title to the Goods passes to the Customer, the Customer shall

(a) Hold the Goods as bailee of PLASSON returnable at will and without prior demand by PLASSON;

(b) Store the Goods in such a manner as enables them to be readily identified and distinguished from all other goods held by the Customer and, where such other goods include goods previously supplied by PLASSON to the Customer and in respect of which title has passed to the Customer, then the Customer shall attach to the Goods in respect of which title has not passed a notice indicating that the Goods are held as bailee for PLASSON.

(c) Upon demand by PLASSON immediately deliver up the goods to PLASSON; and

(d) Authorise and the Customer does hereby authorise PLASSON to enter upon the premises upon which the Goods are stored for the purpose of taking possession of them.

## 7. SERVICE

Some Goods may require recalibration annually or at other periods nominated by PLASSON. The Customer may at its own cost transport and deliver the Goods to and from PLASSON's nominated premises from time to time. On receipt of the Goods, PLASSON agrees to recalibrate the Goods (if necessary) provided that the Customer pays PLASSON its then current service charges in respect of such recalibration.

## 8. INTELLECTUAL PROPERTY LICENCE

PLASSON hereby grants to the Customer a nonexclusive licence to use any software or firmware used in connection with the Goods and supplied by PLASSON. The licence shall be subject to any terms and conditions imposed by PLASSON or the owner of copyright in the software or firmware.

## 9. FINANCIER

9.1. If Plasjon sells the Goods to a third party financier (the "Financier") at the request of the Customer, then PLASSON agrees to grant the licence referred to in Clause 10 to the Customer.

9.2. The Customer represents and warrants to PLASSON that if PLASSON sells the Goods to a Financier at the request of the Customer, the Customer shall continue to be bound by all of the terms of the Agreement in relation to the use of the Goods as if the Customer continued to be the legal and equitable owner of the Goods.

## 10. DELIVERY AND RISK

10.1. The Goods are sold on an Ex Works basis: delivery of the Goods will occur when the Goods are placed at the disposal of the Customer at PLASSON's premises and risk of loss or damage to the Goods then passes to the Customer. In these circumstances, PLASSON may agree to arrange carriage of the Goods for the Customer, but will do so as the agent for the Customer and delivery will occur and risk will pass when the Goods are placed at the disposal of the carrier. The Customer shall pay to PLASSON its Charges for carriage incurred upon the Customer's behalf.

10.2. Delivery dates represent only an estimation of the date of delivery of the Goods and are not binding on PLASSON. Nothing in the Confirmation of Order shall be construed as making time of the essence in the Agreement unless it is expressly stated to be so.

10.3. PLASSON reserves the right to deliver the Goods by installments and to invoice the Customer for each installment of Goods delivered where, in the opinion of PLASSON, it is reasonable to do so.

10.4. Failure by the Customer to pay for any installments, or any other amounts when due, shall entitle PLASSON to withhold or delay delivery of any remaining Goods.

10.5. If PLASSON determines that it is or may be unable to deliver the Goods within a reasonable time or at all, PLASSON may at its sole discretion terminate the Agreement. In the event of termination the Customer shall have no claim against PLASSON for any damage, loss or expense whatsoever.

10.6. If PLASSON is unable to effect delivery, PLASSON may store the Goods and charge the Customer for all costs and expenses associated with such storage and delayed delivery.

10.7. Subject to any express warranty provided in writing by PLASSON to the Customer, failure by the Customer to notify PLASSON within seven days of delivery that the Goods are not in accordance with their description in the Confirmation of Order shall constitute an unqualified acceptance of the Goods and a waiver by the Customer of all claims with respect to the Goods.

10.8. In arranging carriage, storage, insurance and forwarding of the Goods PLASSON shall at all times be acting as the Customer's agent and all Charges in relation to same shall be reimbursed by the Customer. This clause shall also apply to any partial delivery of the Goods.

10.9. Any Goods returned to Plasjon by the Customer other than Goods incorrectly supplied, or Goods with major defects will only be accepted by Plasjon on condition that:

(i) a re-stocking fee of 25% of the Charges applicable to the Goods plus GST and return freight charges are paid by the Customer to Plasjon; and (ii) delivery by the Customer of a Return Authority from Plasjon; and (iii) the Goods are of merchantable quality.

## 11. IMPLIED TERMS AND LIMITATION OF LIABILITY

11.1. Where conditions, warranties or other rights for the benefit of the Customer are implied or given in respect of the Agreement by Competition and Consumer Act, 2010 and / or the Sales of Goods Act 1896 (as amended) or other laws and it is not lawful or possible to exclude the same, then such conditions, warranties or other rights shall (but only to the extent required by law) apply to the Agreement, Save as aforesaid all such implied conditions, warranties and rights are hereby excluded.

11.2. To the extent permitted by law, liability of PLASSON for breach of this contract by PLASSON or negligence of PLASSON or for breach of any conditions or warranty implied by the Competition and Consumer Act, 2010 and / or the Sales of Goods Act 1896 (as amended) shall be limited to one of the following at PLASSON's option:

(a) the replacement of the Goods or the supply of equivalent Goods; or

(b) the repair of the Goods; or

(c) the payment of the costs of replacing the Goods or of acquiring equivalent Goods;

(d) the payment of the cost of having the Goods repaired; and in the case of services supplied, to one of the following (as PLASSON may determine): (1) the supplying of the services again, or (2) the payment of the costs of having the services supplied again.

11.3. Save as expressly provided in any written warranty provided in writing by PLASSON to the Customer and in Clauses 11.1 and 11.2 and not withstanding any implication arising from any other clauses in the Agreement, PLASSON shall not be liable to the Customer or any person claiming under it in contract or in tort for, or in respect of, any direct, indirect or consequential loss, damage, expense or injury suffered by the Customer or any other person whatsoever, arising out of, in connection with or relating to the performance,

non-performance or any breach of the Agreement (including, by way of illustration and not in limitation, liability due to the negligence or wilful default of PLASSON) or any matter relating to the Agreement or any error (whether negligent or not) in information supplied to the Customer before or after the date of the Agreement in connection with its subject matter. "Consequential loss" shall include but not be limited to loss of profit, use or good will (or similar financial loss), payment made or due to any other person and any loss or damage caused by delay in the performance of any obligation, together with any expenses incurred by the Customer in connection therewith, arising therefrom or incurred in mitigation or attempted mitigation of such loss or damage.

11.4. Clause 11.3 shall apply to all express warranties provided in writing by PLASSON except to the extent that those warranties specifically provide otherwise.

11.5. Where any law implies into the Agreement a condition that the Goods are of merchantable quality, and the Goods are purchased by the Customer for particular purpose, the Goods will not be considered by the Customer as being fit for any other purpose, whether or not that other purpose is one for which goods of that kind are commonly bought.

## 12. DEPOSIT

12.1. Where PLASSON agrees to supply Goods upon the condition that a deposit of part or all of the charges is paid prior to delivery ("the Deposit"), in the event that the Customer terminates the Agreement or fails to take delivery of the Goods or is otherwise in breach of its obligations to PLASSON so that PLASSON is entitled to terminate the Agreement, the Customer shall forfeit ten per cent of the Deposit to PLASSON for PLASSON's benefit and PLASSON shall refund the balance to the Customer.

12.2. The forfeiture of the Deposit shall not be deemed any limitation, in damages or otherwise including damages for loss of profits, of the liability of the Customer to PLASSON.

### 13. TERMINATION

In addition to the rights of termination provided in the above conditions, PLASSON may terminate the Agreement upon the occurrence of any of the following events.

- (a) Failure by the Customer to perform any obligation of this Agreement where such failure is not rectified within 30 days of notice from PLASSON requesting rectification.
- (b) The Customer becomes bankrupt or an order is made or a resolution is passed for the winding up of the Customer or a ground arises on which a court may order its winding up or upon which a meeting may rely for the purposes of placing the Customer under official management or an inspector is appointed to investigate its affairs or it proposes to or enters into any arrangement, scheme, reconstruction or composition with creditors.
- (c) A receiver of receiver and manager of the Customer's assets, income or business or any part thereof is appointed or a mortgagee goes into possession thereof and such appointment is not terminated or such possession does not cease within fourteen days.
- (d) The Customer shall fail to pay its debts as they shall fall due or cease or threaten to cease to carry on business or sell, assign, transfer the whole or any part of its undertaking or assets otherwise than in the ordinary course of business.
- (e) The Customer purports to assign its rights under the Agreement.
- (f) Any event occurs outside the reasonable control of PLASSON which in PLASSON's estimate makes it impracticable or impossible for it to fulfil its obligation under the Agreement.

### 14. FORCE MAJEURE

14.1. PLASSON will not be liable for any loss or damage suffered by the Customer due to any delay or any breach or default under the Agreement in circumstances where such delay, breach or default results from causes beyond PLASSON's reasonable control including but not limited to any breach or default under the Agreement by the Customer, compliance with any laws, regulations, orders, acts, instructions or priority requests of governments, acts of God, fires, floods, weather, strikes, lockouts, factory shutdown or alterations, embargoes, wars, riots, delay or shortage in transportation or inability to obtain labour, manufacturing facilities, electricity, oil or other materials from PLASSON's or the Manufacturer's usual sources.

14.2. Any delay resulting from such cause shall immediately extend the delivery date by the period of delay in which event the Customer shall take, if necessary, steps to secure payment for the Goods.

### 15. MISCELLANEOUS

15.1 Any indulgence, latitude or extension of time which PLASSON may show towards the Customer in relation to any of the provisions of the Agreement or any matter or thing relating thereto or arising therefrom shall not in any way prejudice or interfere with PLASSON's rights under the Agreement and shall not be claimed to constitute a waiver thereof.

15.2 The Customer acknowledges that no oral terms or representations form part of the Agreement unless they have been reduced to writing and signed by PLASSON prior to entering into the Agreement.

15.3 Any notice to be given to a party shall be in writing and shall be sent by post, email or facsimile to the address of that party as shown in the Confirmation of Order or as subsequently notified by that party to the party giving the notice and shall be deemed to have been given at the time it would have been received in the normal course of post if forwarded by post and if otherwise given at the time it was actually received.

15.4 The Agreement shall be governed by the laws of New South Wales and the parties agree to submit to the jurisdiction of the Courts for that State.

15.5 In the event of PLASSON seeking to recover any amount due from the Customer or to enforce any of its other rights under the Agreement, the Customer undertakes to pay to PLASSON any costs incurred by PLASSON in so doing, including any legal costs incurred on the solicitor and own client basis.

### 16. SECURITY INTEREST

(a) The Customer hereby acknowledges that these terms and conditions of sale constitute a security agreement which creates a Security Interest in favour of PLASSON and in all Goods supplied by PLASSON to the Customer and all after acquired Goods supplied to the Customer by PLASSON (or for the Customer's account) to secure the payment from time to time for Goods, including future advances. The Customer agrees to grant to PLASSON a Purchase Money Security Interest. (b) The Customer gives PLASSON a Security Interest in all of its present and after acquired property in which Goods supplied or financed by PLASSON have been attached or incorporated, including any Commingled Goods and in any proceeds of sale of Goods.

### 17. GENERAL COVENANTS

(a) Until such time as payment in full has been received by PLASSON from the Customer in respect to an Order, the Customer covenants to PLASSON not to create, cause or permit to exist any other Security Interest over any Goods the subject of the applicable Order, other than a Permitted Security Interest and covenants that it shall comply with the terms of each Permitted Security Interest binding on it in respect of the relevant Goods from time to time and shall ensure that: (i) there is no increase in the amount secured under a Permitted Security Interest (excluding any part of a Permitted Security Interest which is a purchase money security interest); and (ii) there is no variation to a Permitted Security Interest that increases the collateral the subject of the Permitted Security Interest, other than in the case of a purchase money security interest, without obtaining the prior written consent of PLASSON. (b) The Customer covenants to PLASSON that it shall sign anything and do anything PLASSON requires to further or more effectively secure PLASSON's rights over the applicable Goods or under these terms and conditions. This includes anything PLASSON requires in order for it to: (i) register and maintain (including renew before expiry) one or more financing statements in relation to any Security Interest in the relevant Goods created by these terms and conditions and/or any Order; (ii) remove any financing statement which is registered against the Customer or in relation to a Security Interest which is not a Permitted Security Interest; and (iii) obtain possession or control of any Goods for the purposes of perfecting any Security Interest in that property by possession or control for the purposes of the PPSA. (c) The Customer waives its rights to receive a verification statement in respect of any financing statement or financing change statement registered by or on behalf of PLASSON under the PPSA to the extent permitted by the PPSA and agrees to that as between PLASSON and the Customer, to the extent permitted by the PPSA, the Customer will have no rights under (or by reference to) sections 95, 96, 117, 118, 120, 121(4), 123, 125, 126, 128, 129, 130, 132(3)(d), 132(4), 134(1), 135, 142 and 143 of the PPSA.

## We support our Distributors:

- ✓ Service excellence through local expertise and comprehensive field support
- ✓ Fast, accurate and efficient dispatch of products
- ✓ Merchandising assistance – smart way to display stock and promote your range of Plasson fittings
- ✓ Reliable products – over forty years of proven performance in harsh Australian conditions
- ✓ Attractive commercial arrangements
- ✓ Opportunities in new markets such as plumbing, municipal water and larger PE pipe diameter projects
- ✓ Inclusion on our online Plasson stockist store locator to promote your Plasson range

### Exclusive distribution partner for

**SIMONA**



 **PLASSON**®  
**AUSTRALIA**  
GLOBAL PRESENCE • LOCAL COMMITMENT

© Plasson is the registered trademark of Plasson Ltd. © Plasson Australia Pty Ltd 2020.

This material is the property of Plasson Australia Pty Ltd and may not be reproduced or used without the express permission of Plasson Australia Pty Ltd. Advisory information concerning usage of the Company's products is published to assist users to obtain best performance and represents the best information available at time of publication.

No warranty is expressed or implied, nor will any liability be accepted by the Company for any consequences resulting directly or indirectly from the use of such information. Product data and advisory information are subject to change at any time without notice.



## **Sales**

Phone: 1300 752 776

Fax: 1300 248 027

Email: [sales@plasson.com.au](mailto:sales@plasson.com.au)

[www.plasson.com.au](http://www.plasson.com.au)

### **Sydney (Head Office)**

PO Box 6163, Alexandria NSW 2015

### **Brisbane (Office & Warehouse)**

49 Distribution Street, Larapinta QLD 4110

### **Melbourne (Warehouse)**

25 Business Park Drive, Ravenhall VIC 3023

### **Darwin (Warehouse)**

c/- Simon National Carriers, 76 Export Drive, East Arm NT 0822

### **Perth (Warehouse)**

c/- ACFS, 151 Milner Road, High Wycombe WA 6057

PLASSON Australia Pty Ltd